

Térrácsok

Különleges tartószerkezetek

Hajlításmentes térrácsok

- Statikailag határozott
- Statikailag határozatlan
- Kinematikailag határozatlan

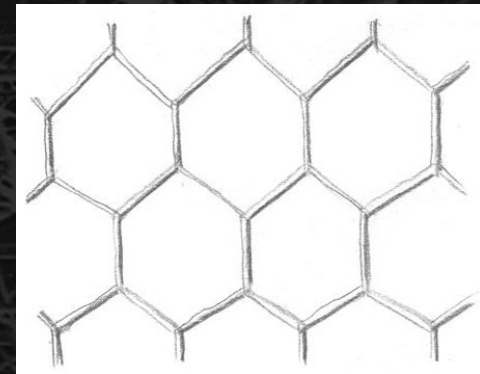
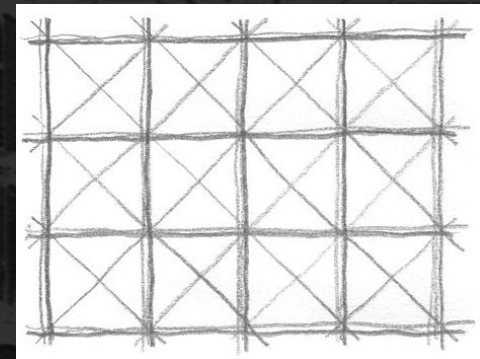
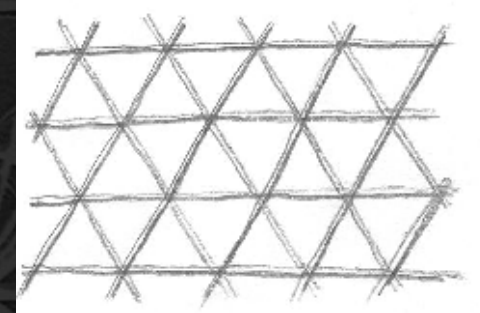

Gömb felosztása

- tetraéder

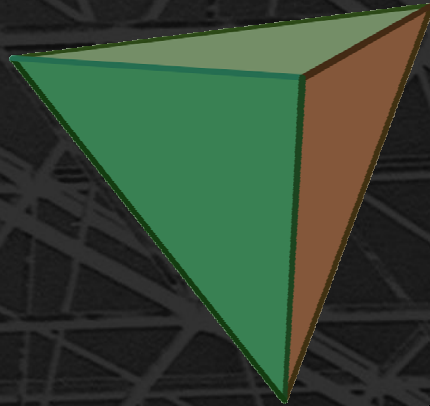

- hexaéder

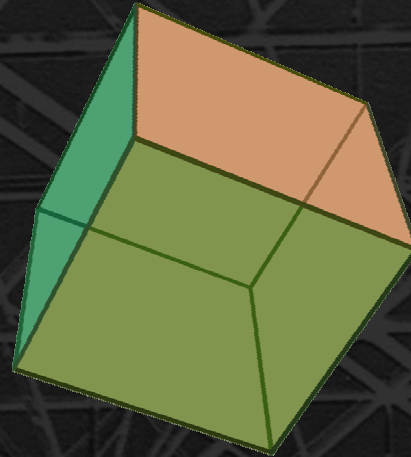

- oktaéder

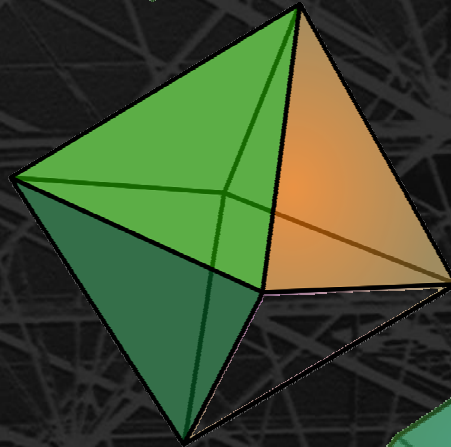

- ikozaéder

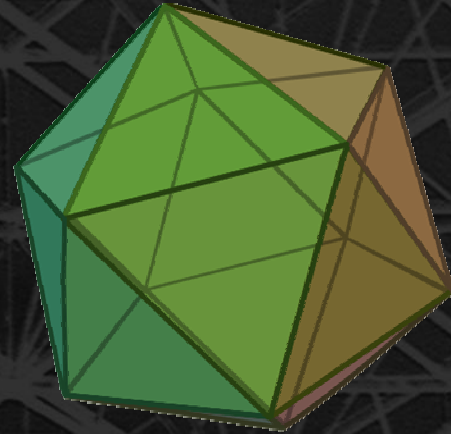

- dodekaéder

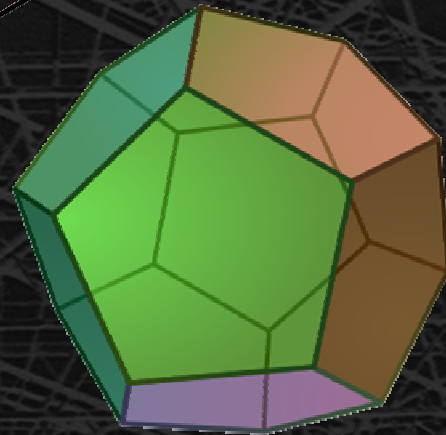

- pentagondodekaéder

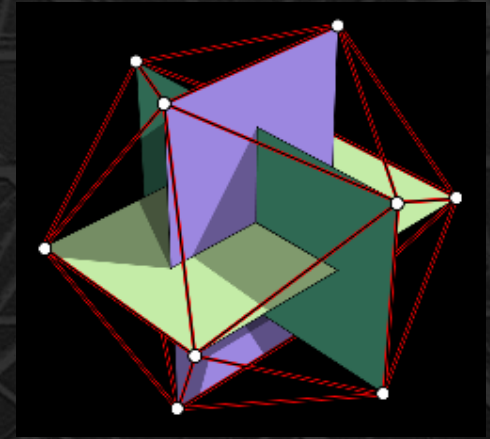
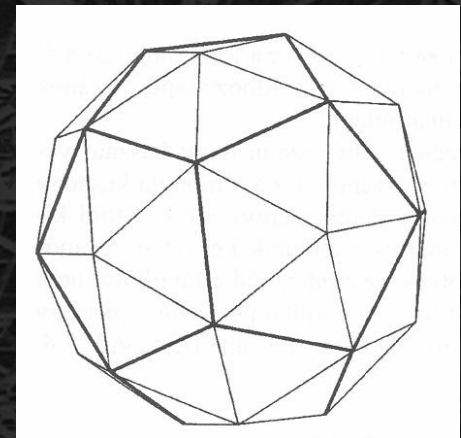

Gömb felosztása

- Buckminster Fuller

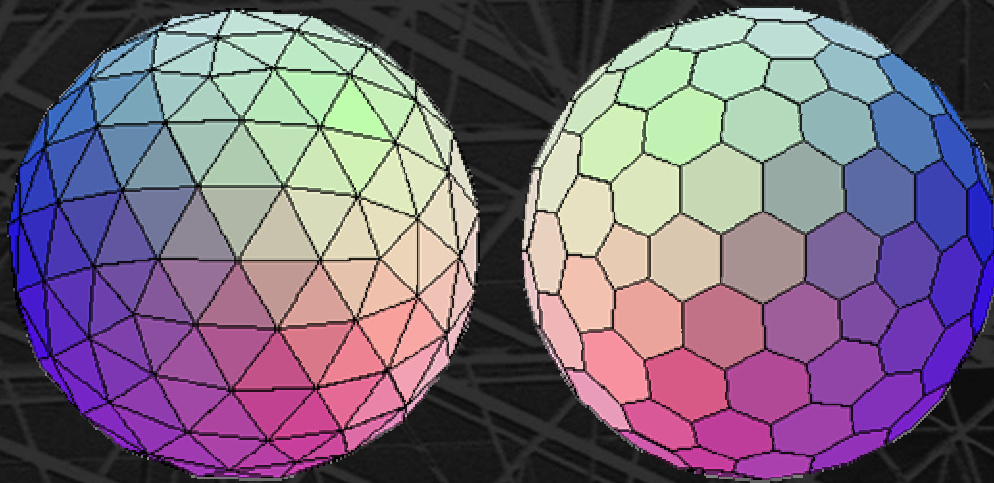

- Tarnai Tibor

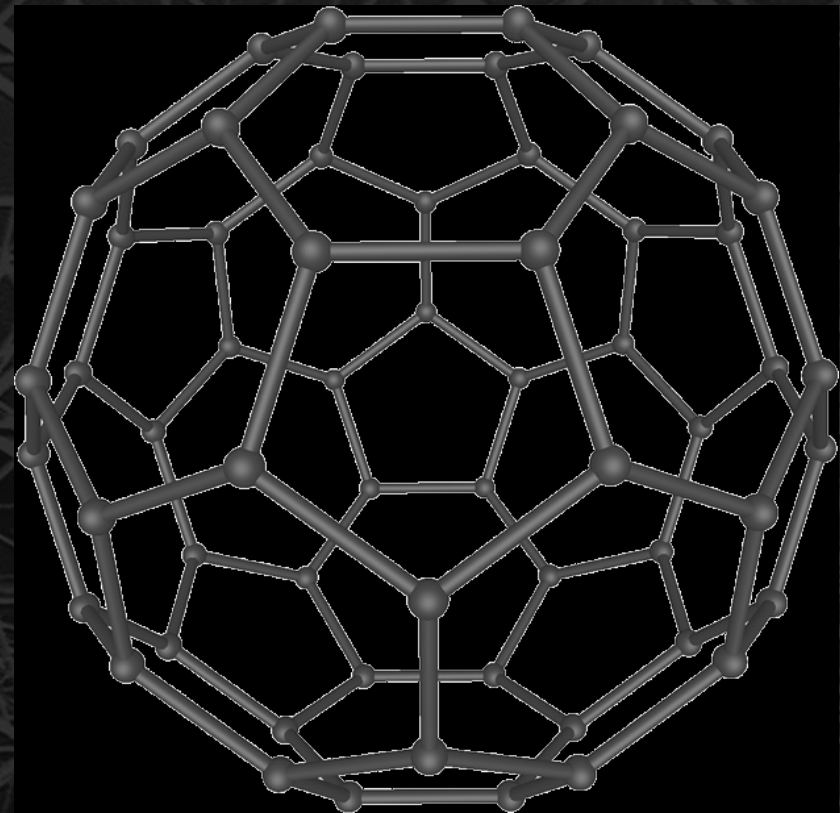
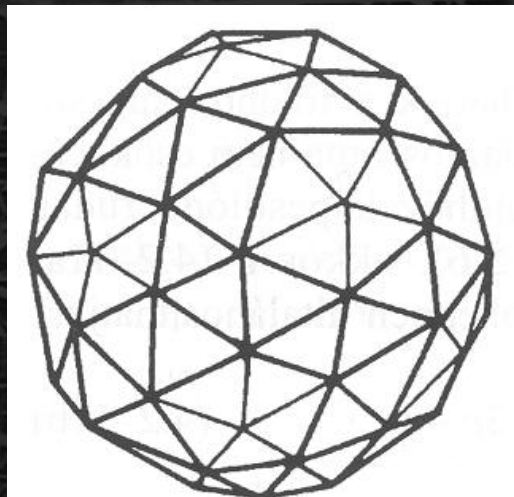

Gömb felosztása

- Gömbsüvegek

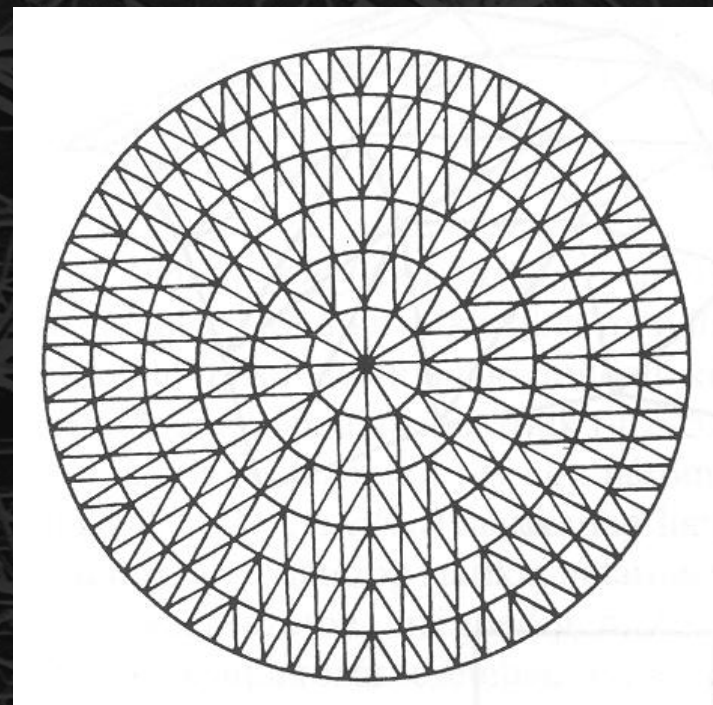
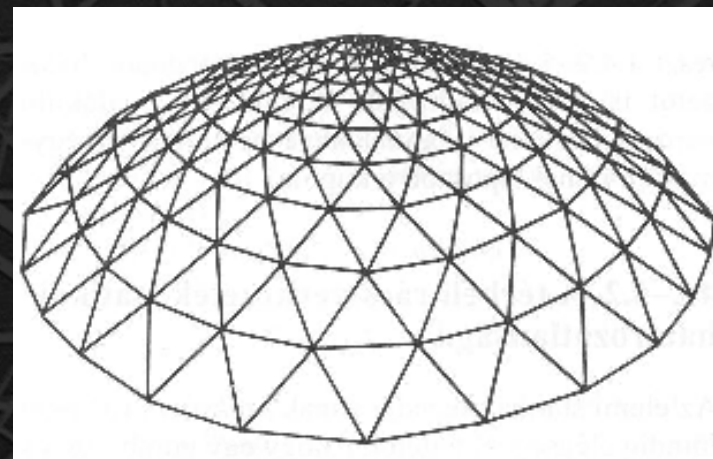
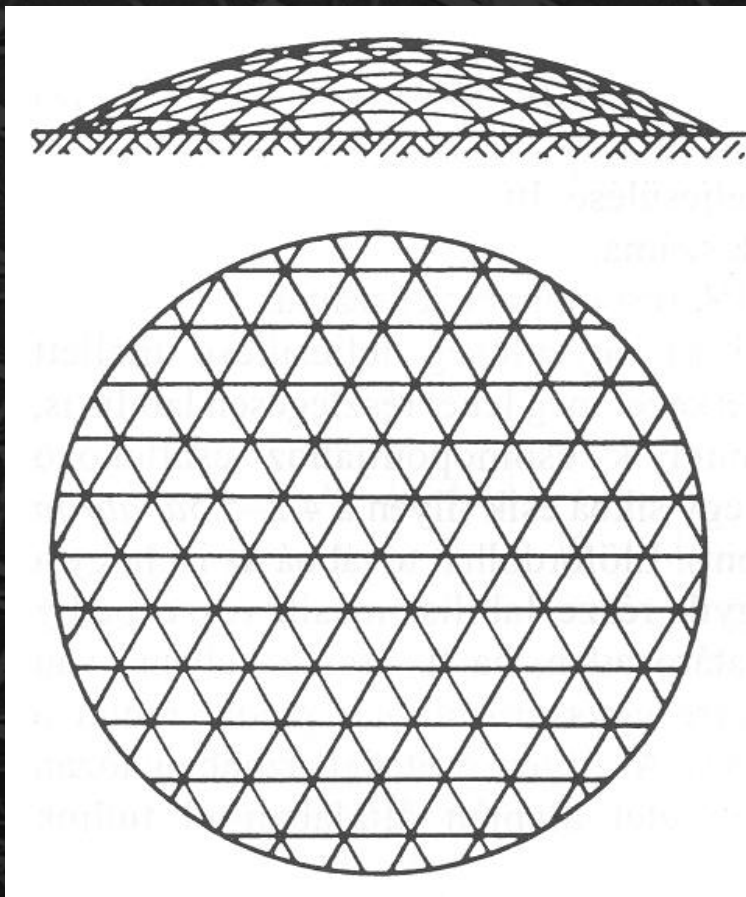

Parabolikus felületek

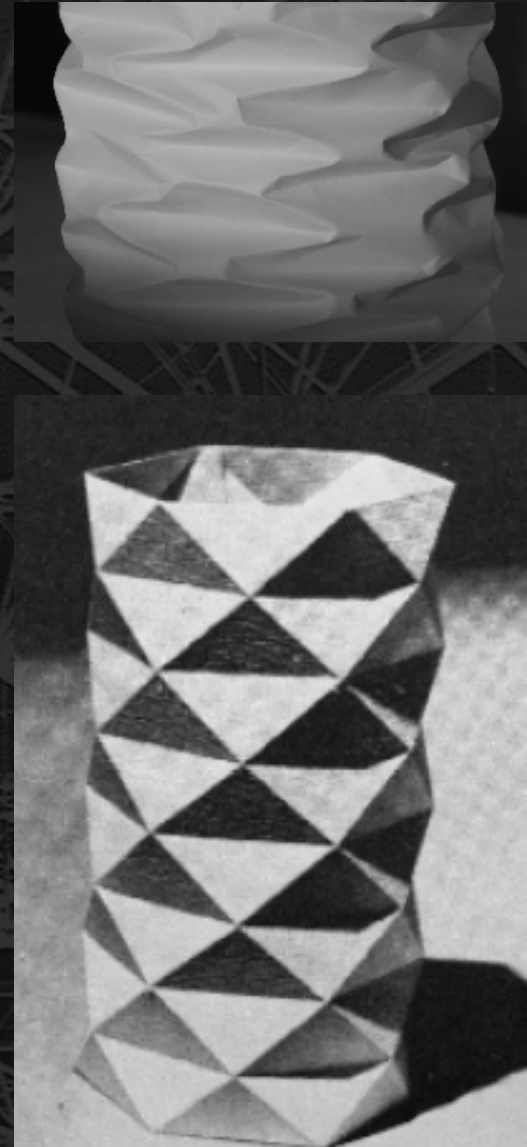
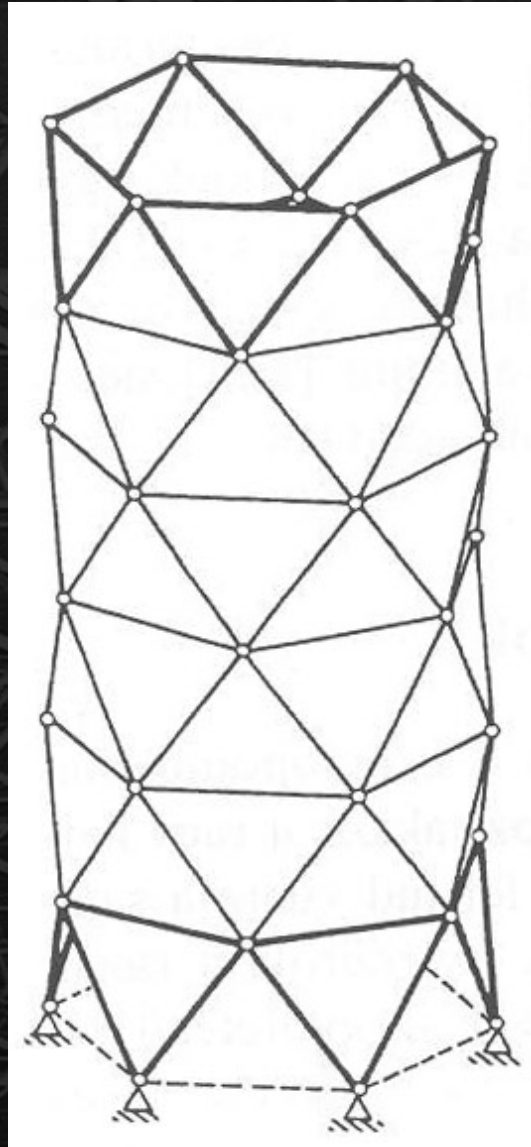
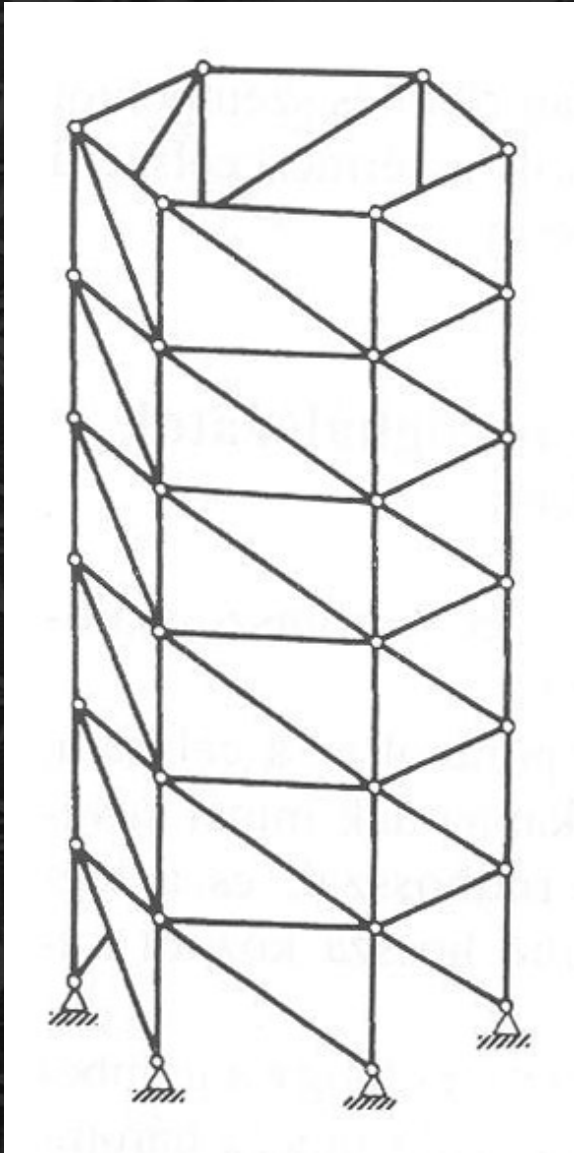

Hiperbolikus felületek

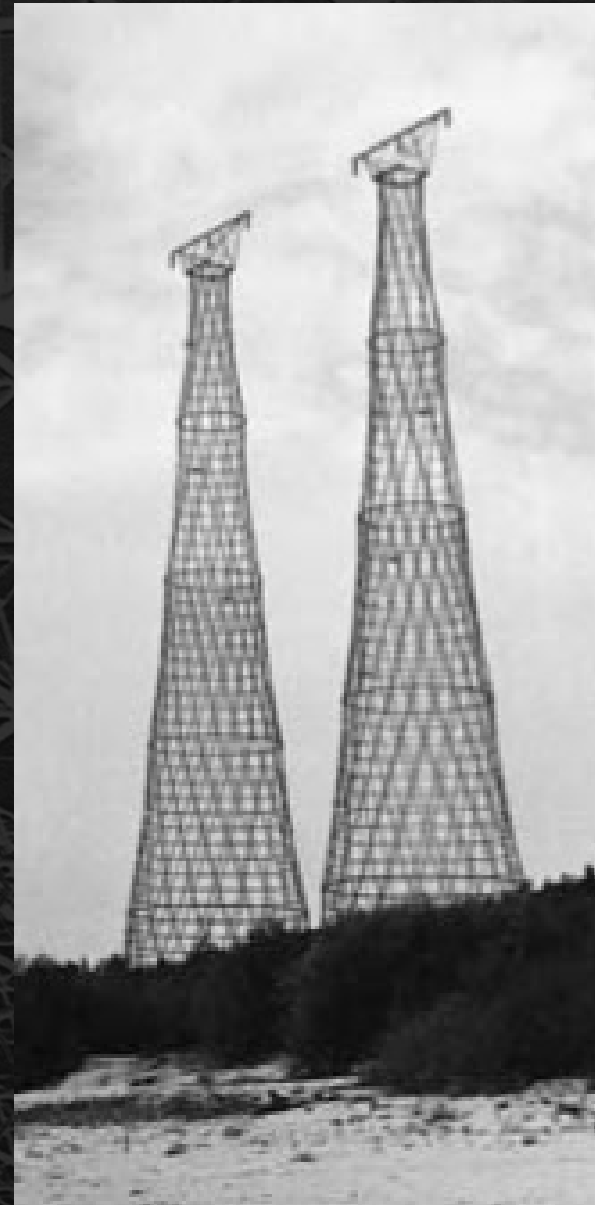

Szabadon formált felületek

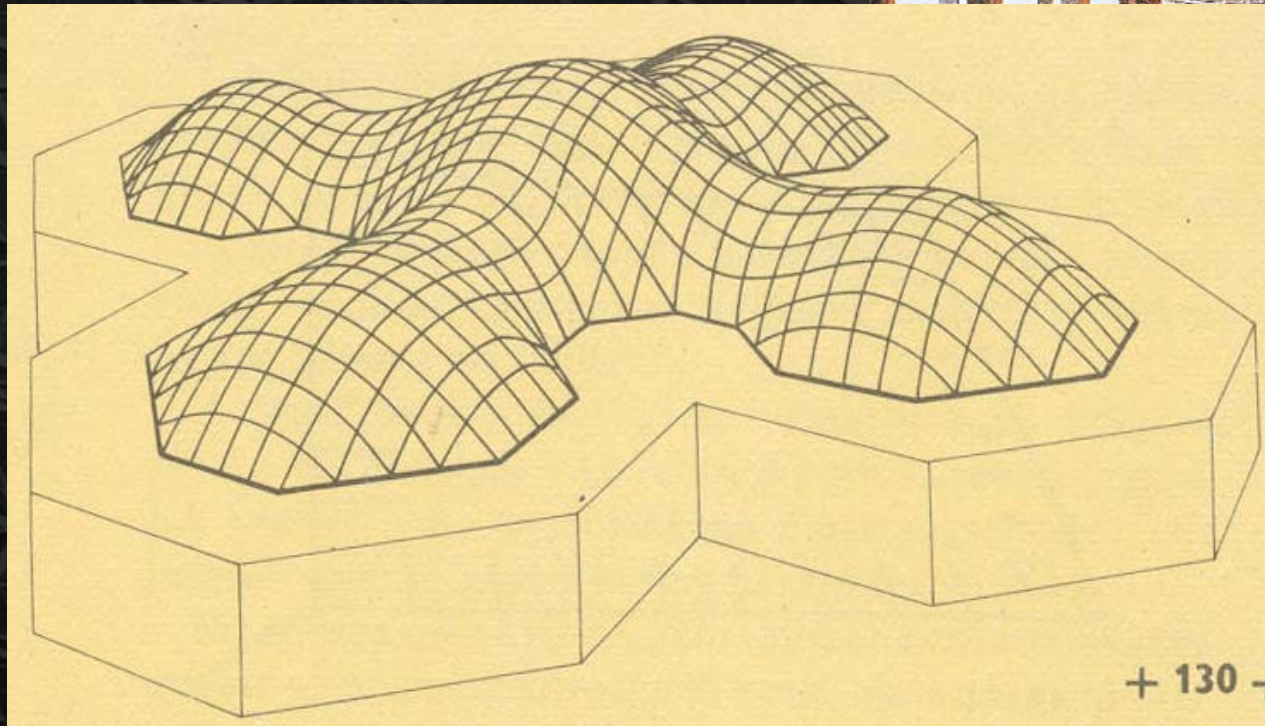
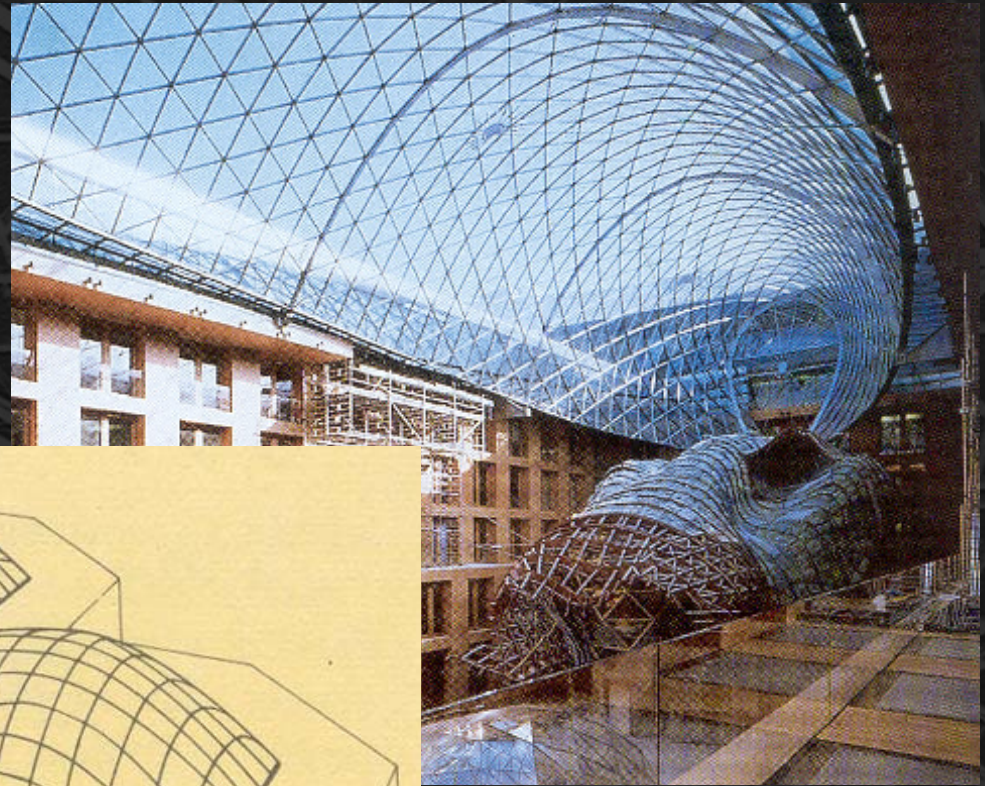

Nexorade

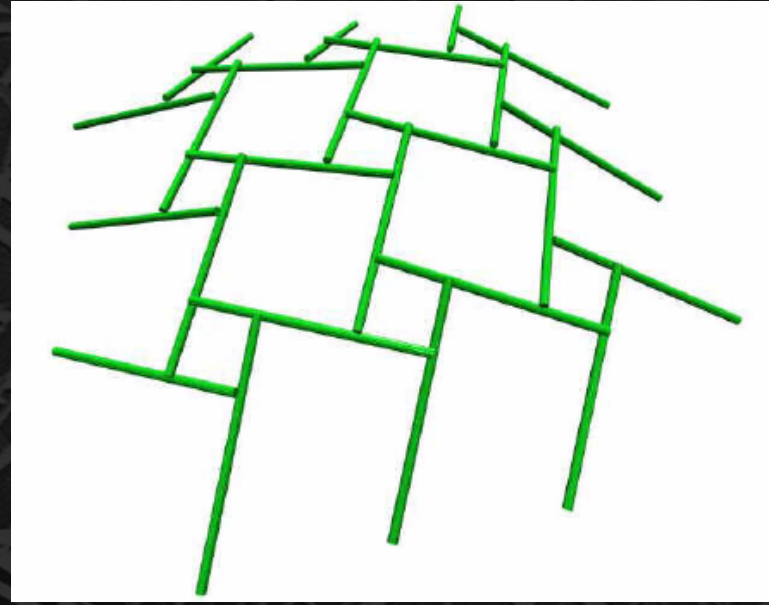
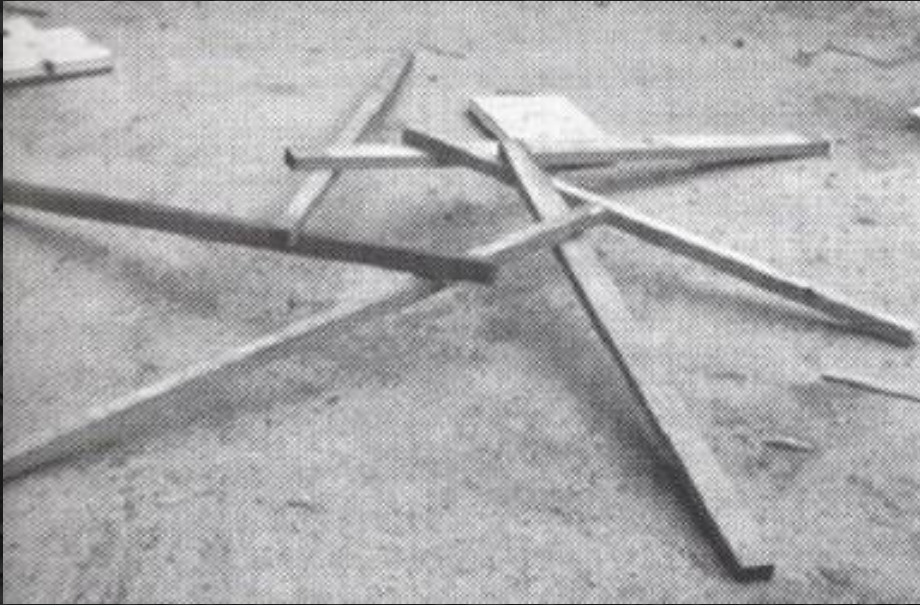

Nexorade

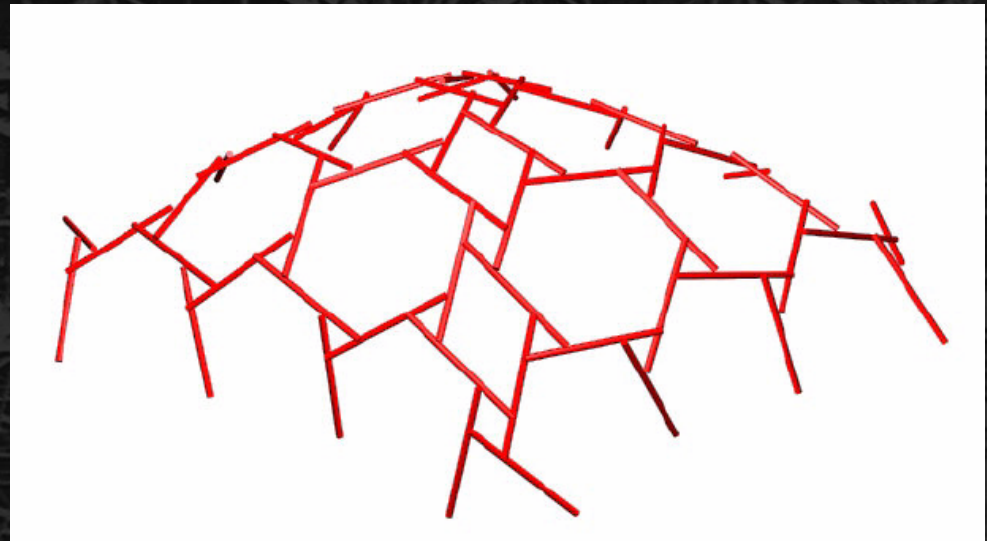
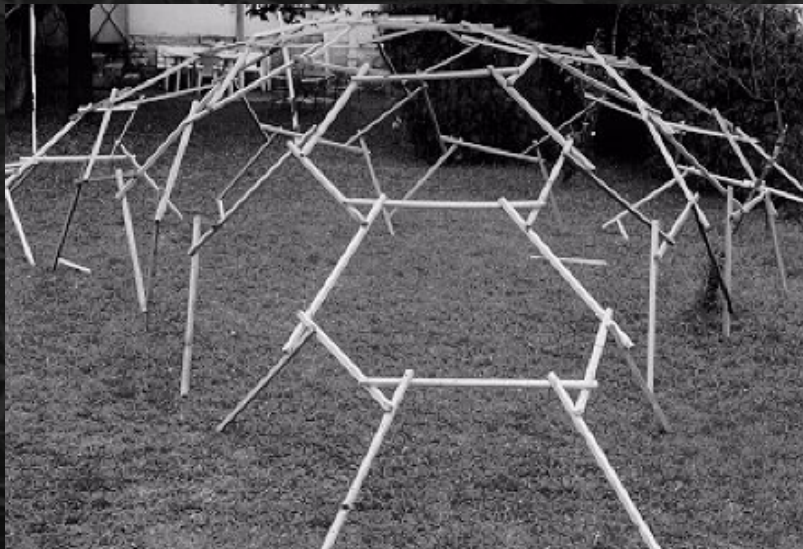
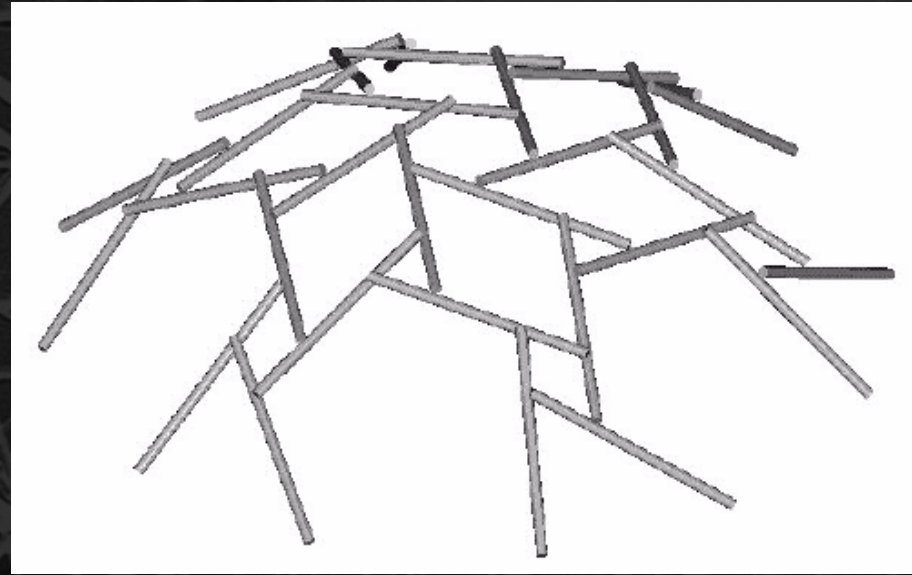
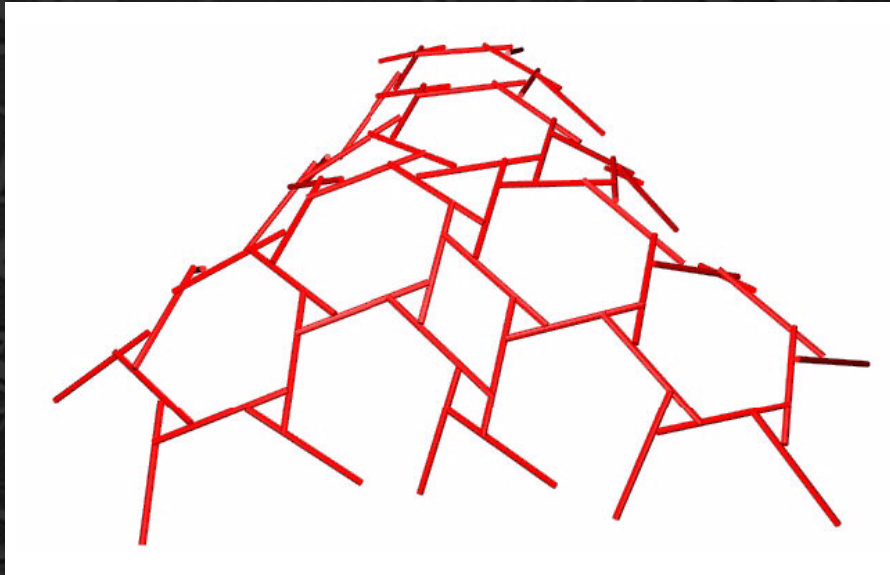

Nexorade

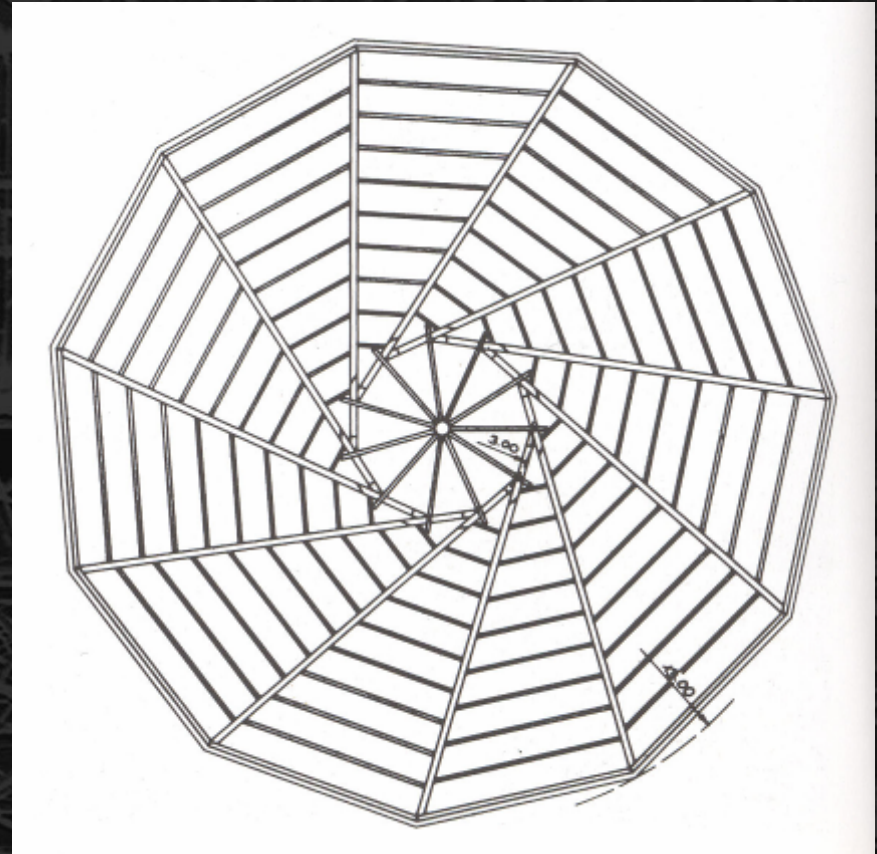
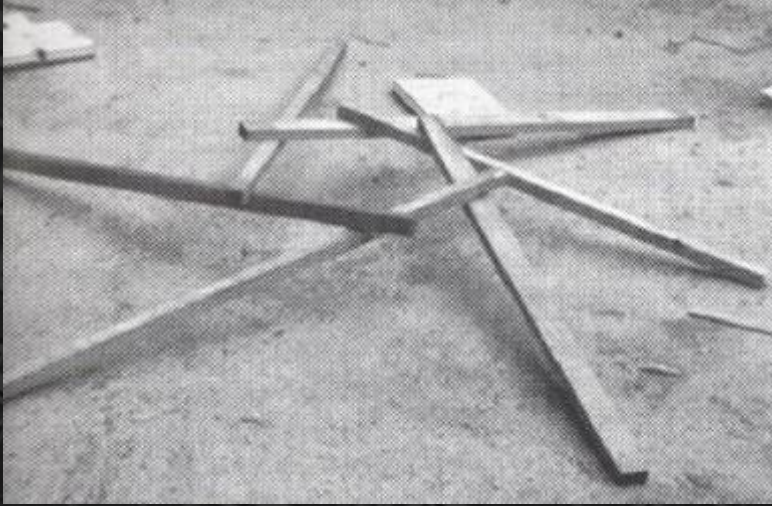

Tensegrity

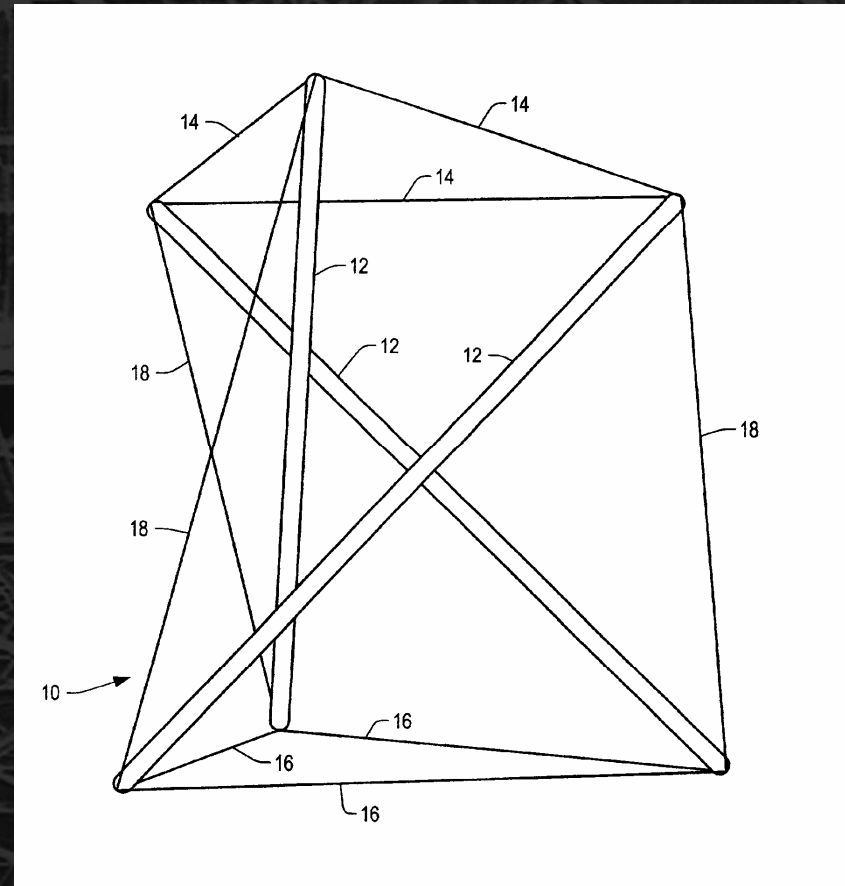
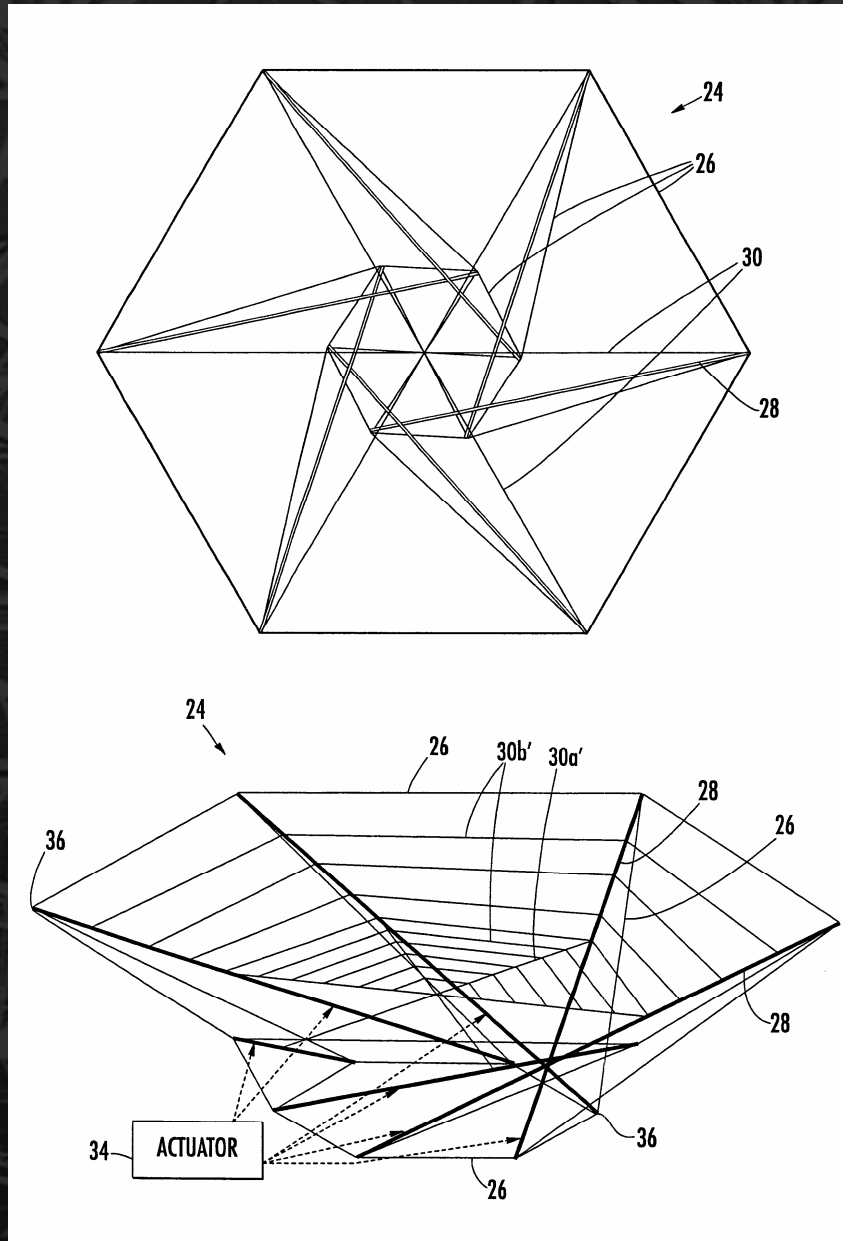

Tensegrity

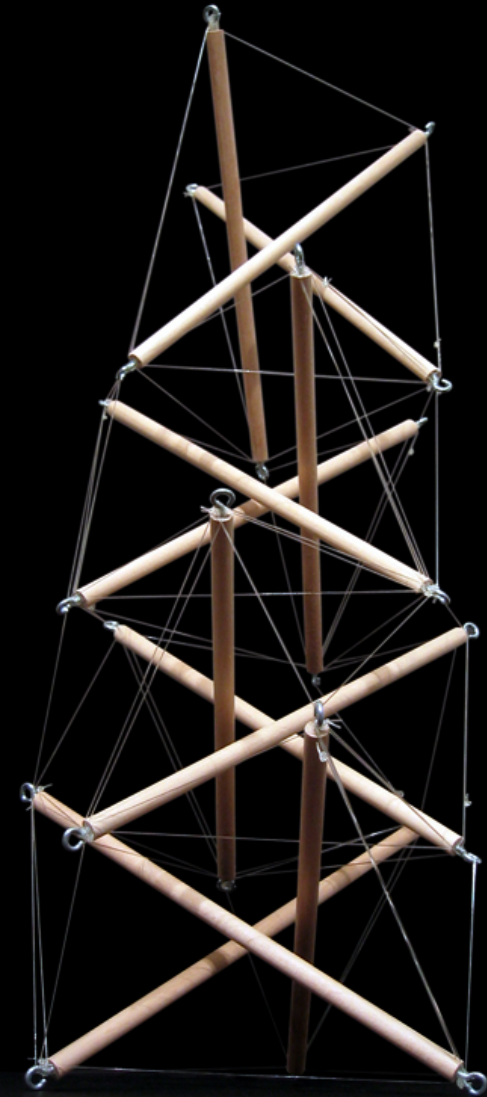
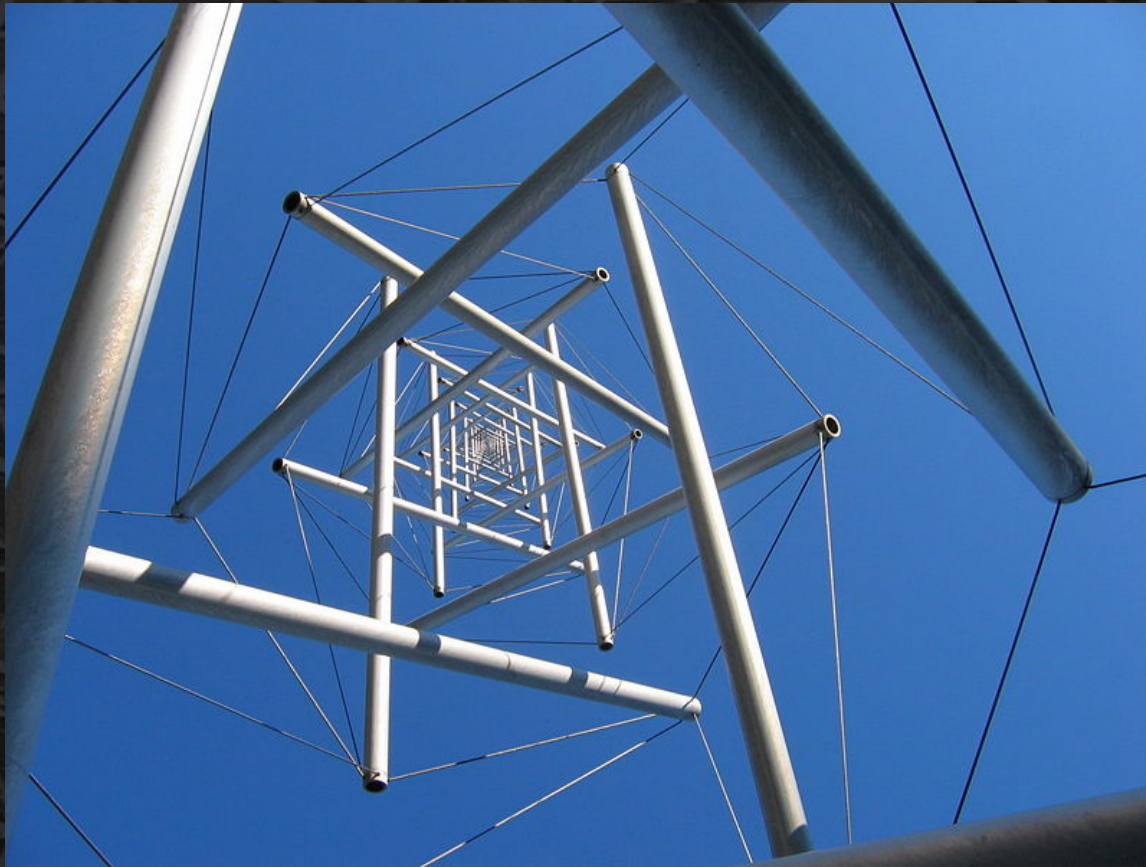

Tensegrity

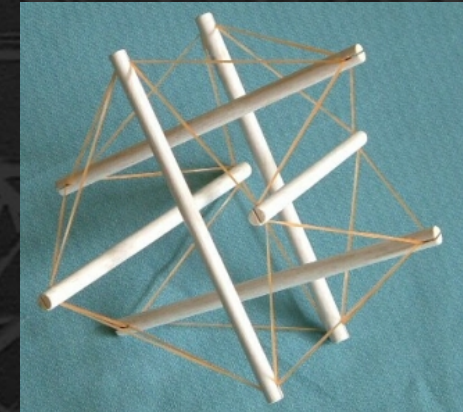
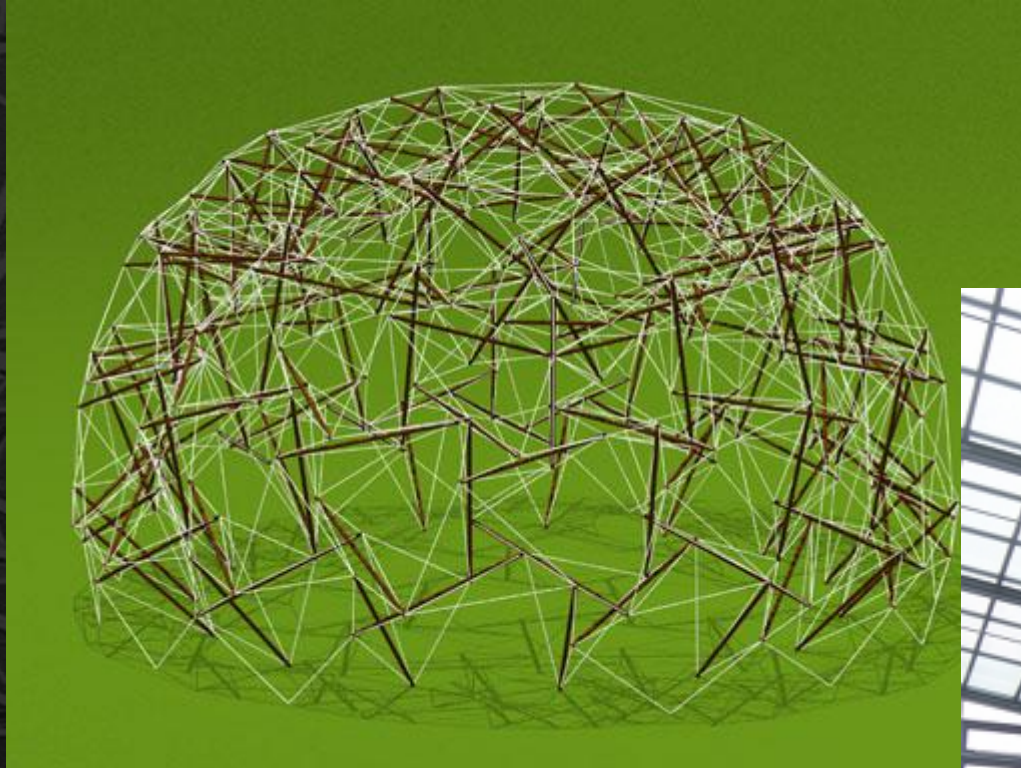

Tensegrity

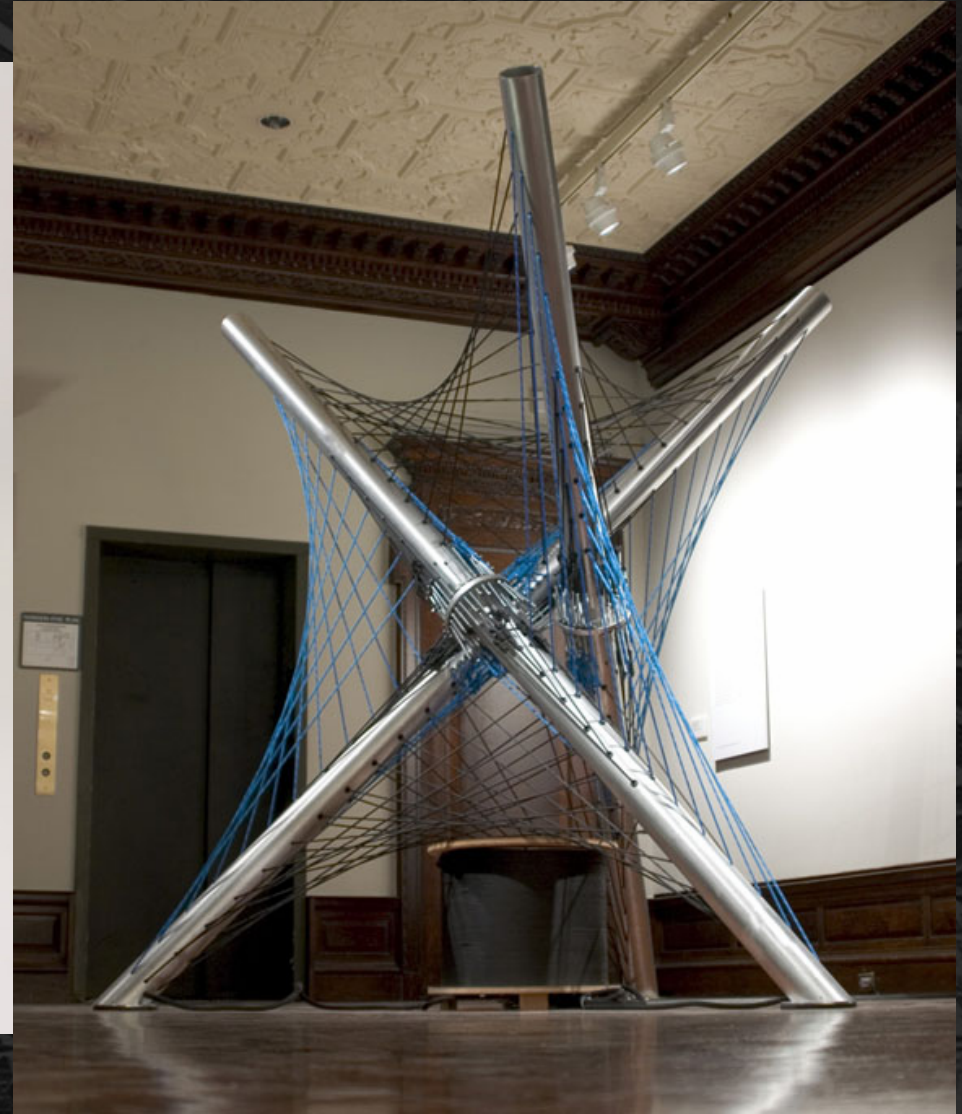

Tensegrity

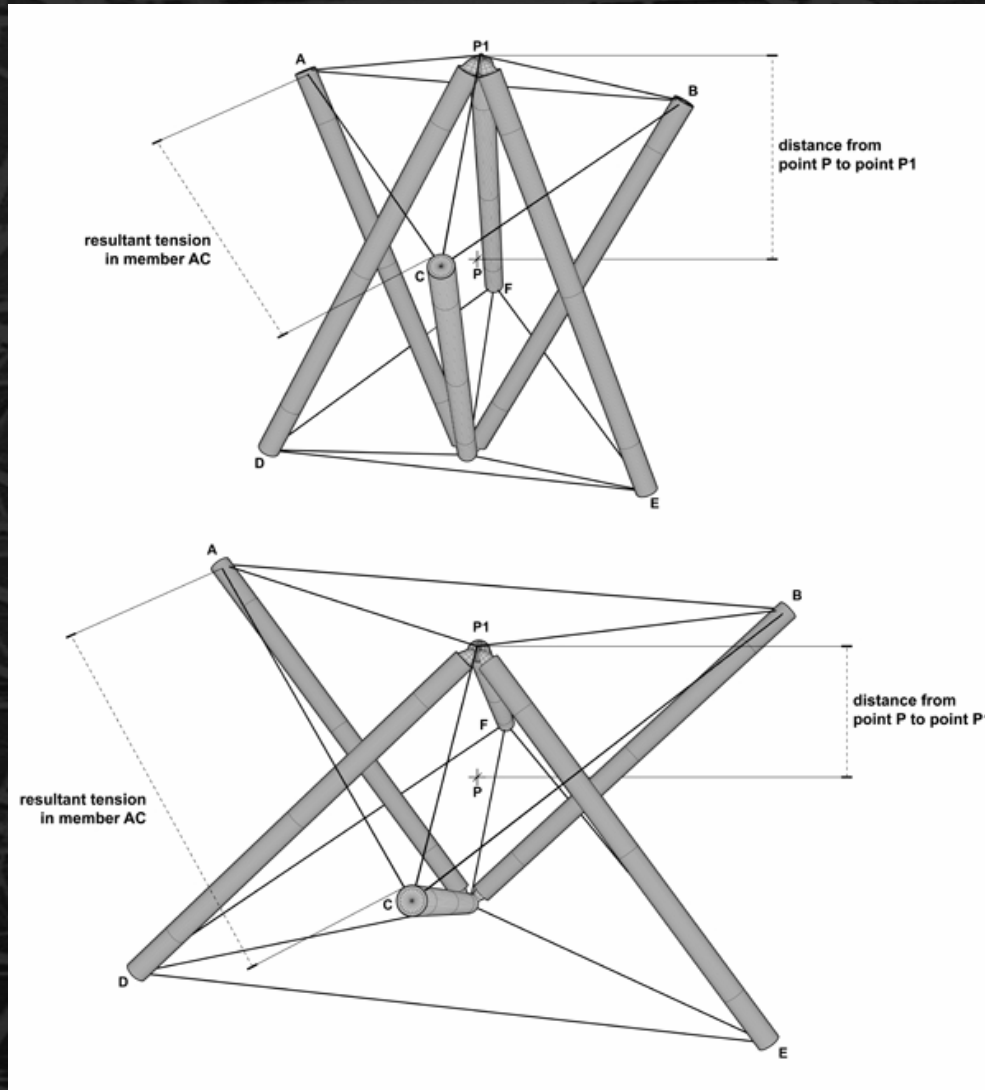

Léocrács héjak

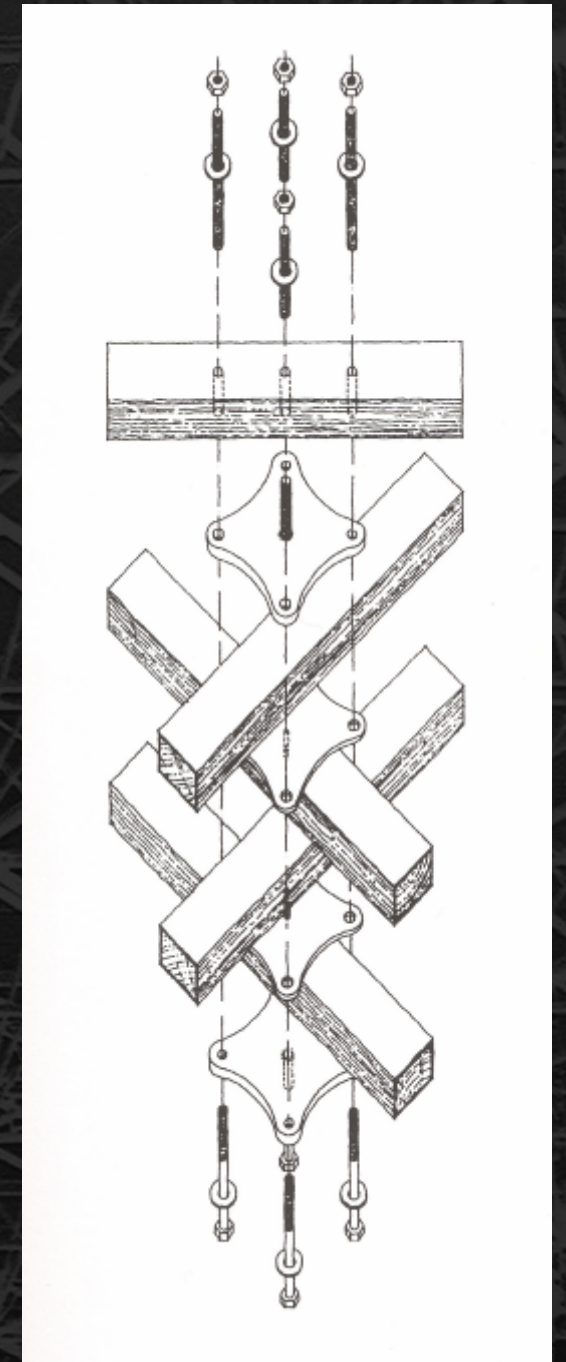

Hajlított térrácsok

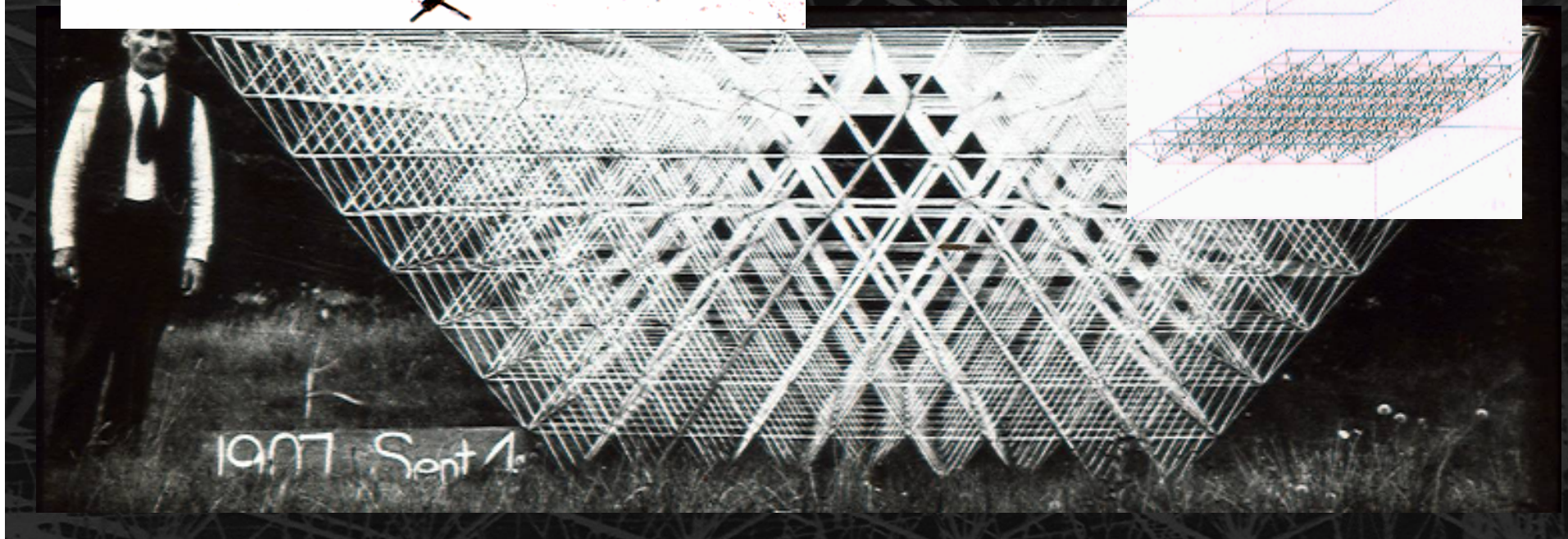
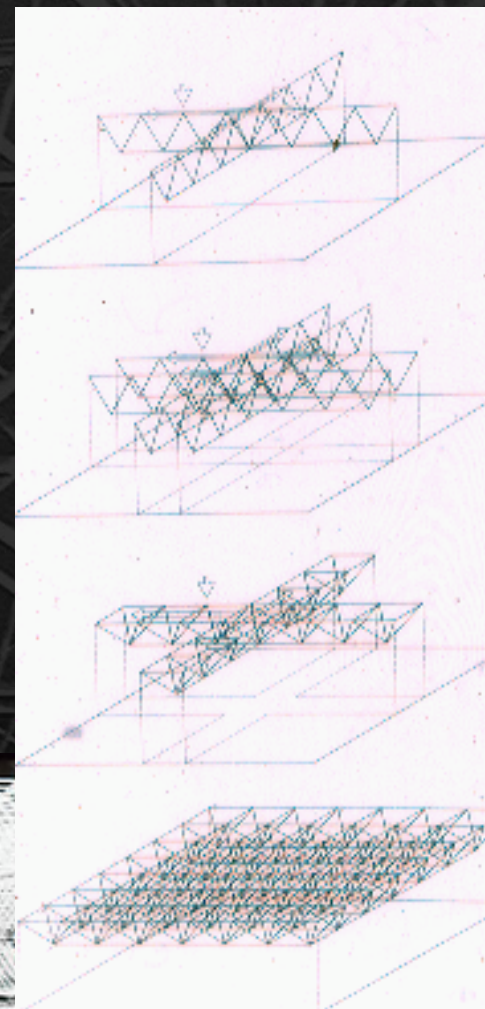
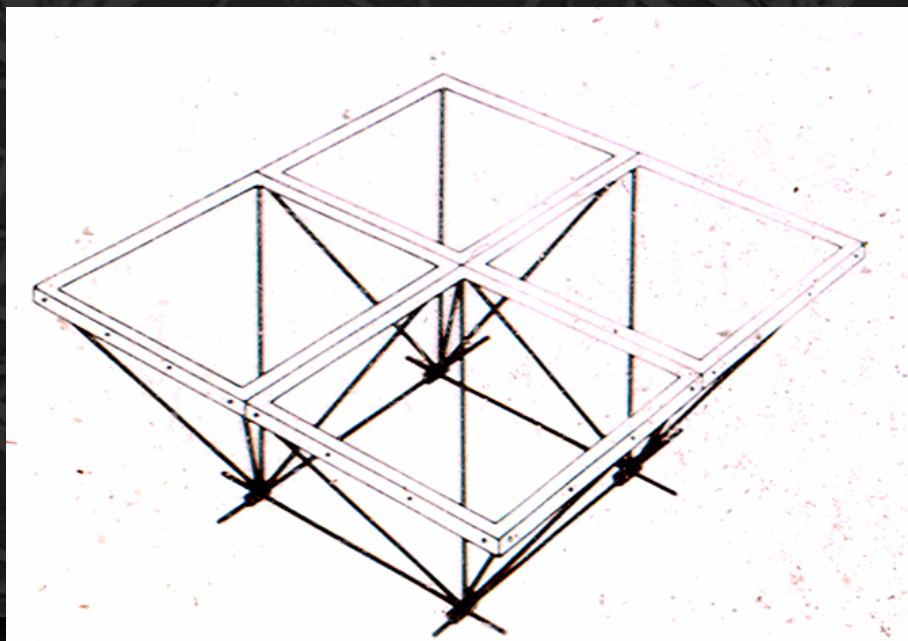

Hajlított térrácsok

- Az övsíkok merevsége arányos
 - Az övsíkok merevsége nem arányos
 - Az egyik övsík merevsége hiányos (csővel merevített)
-
- Izotrop
 - Orthotrop
 - Aelotrop

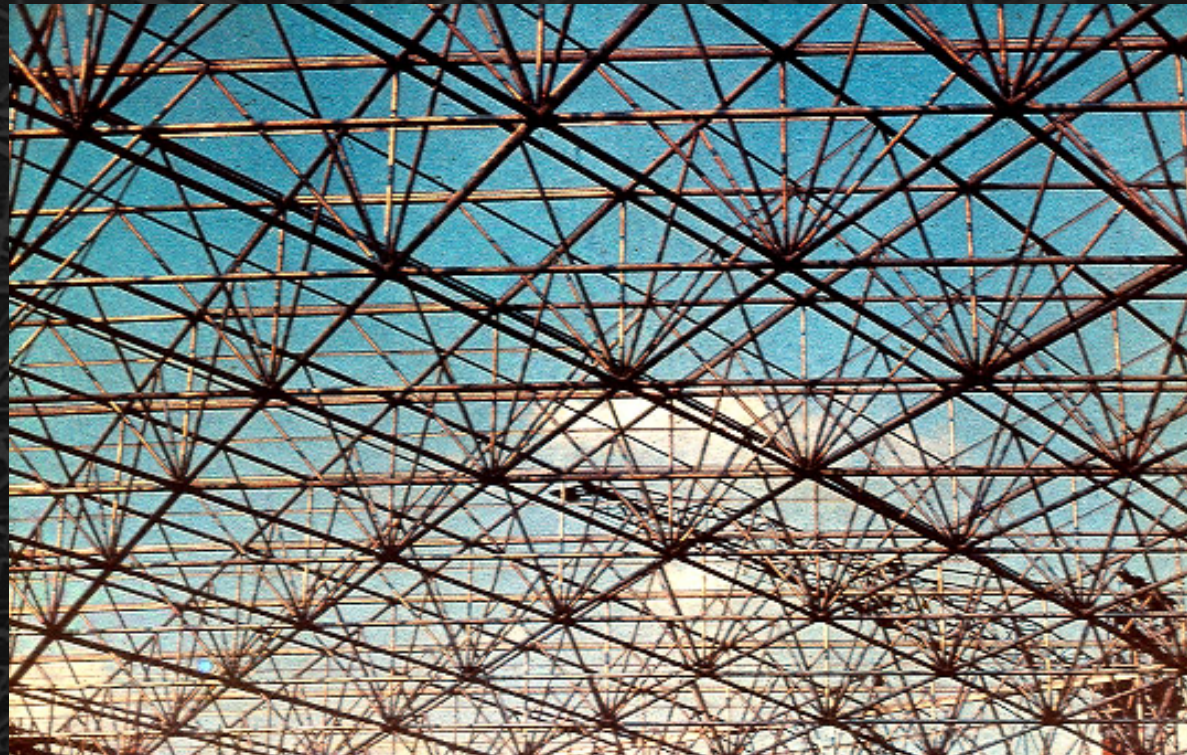

Kapcsolatok (Kipszer)

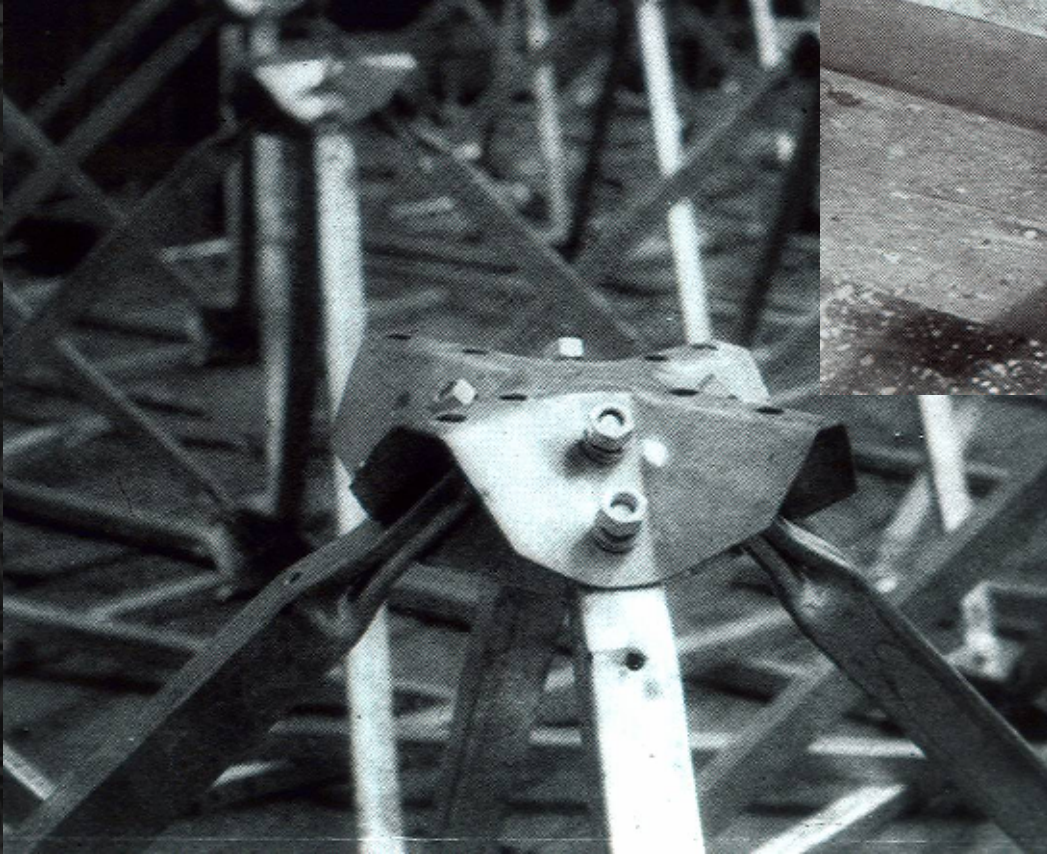
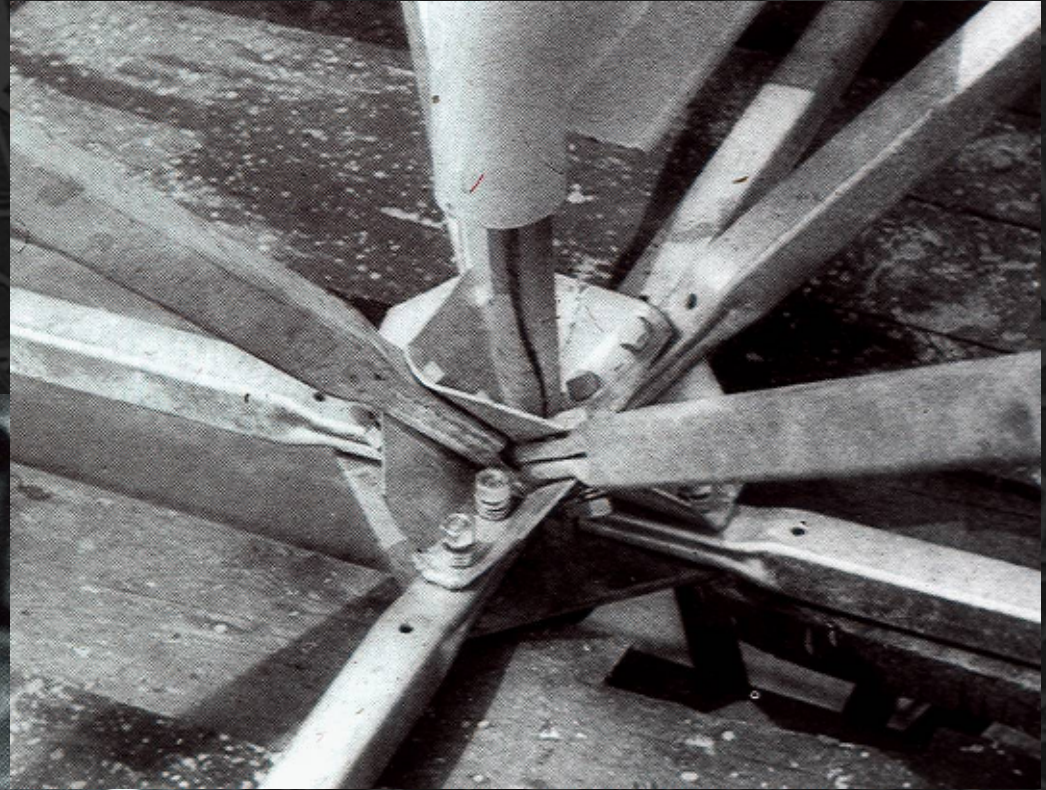

Kapcsolatok (Mero)

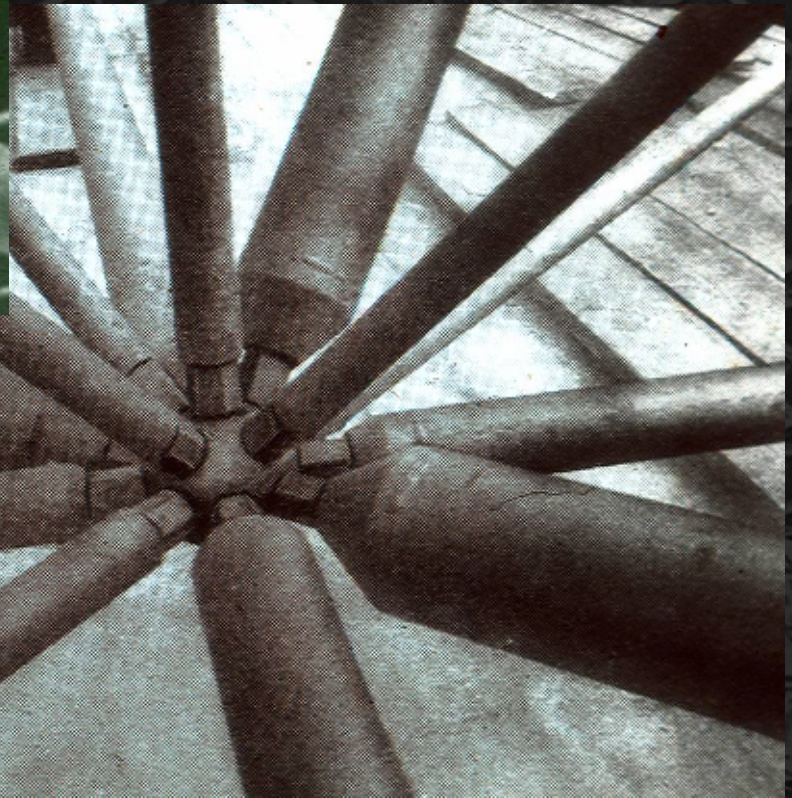
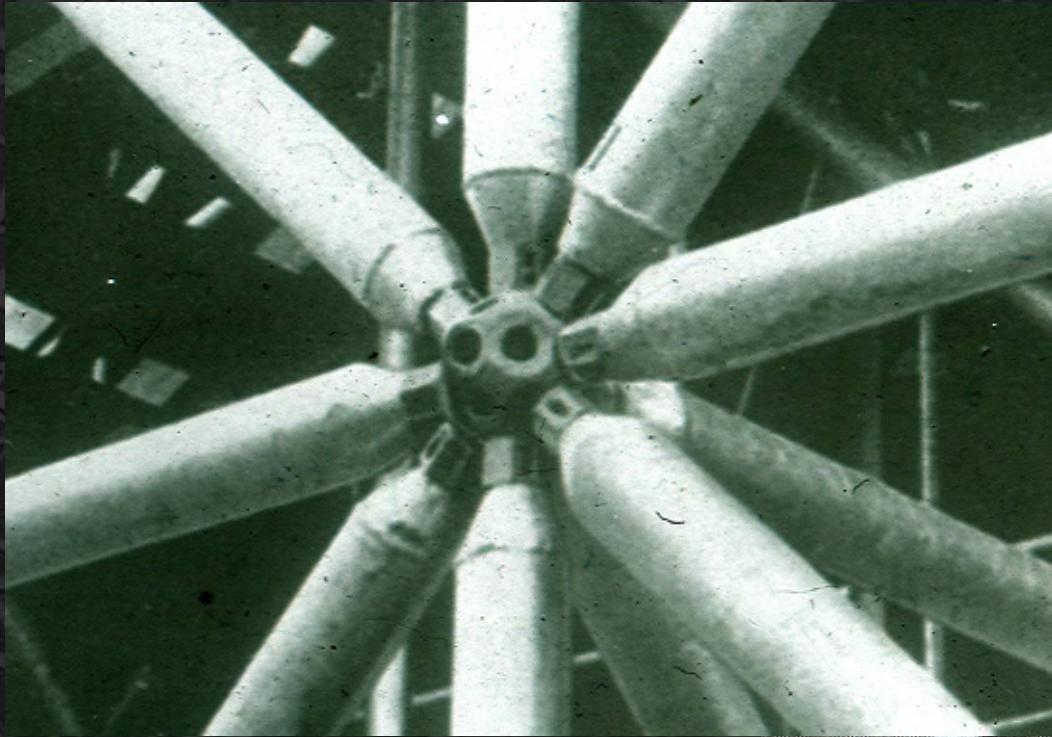

Kapcsolatok

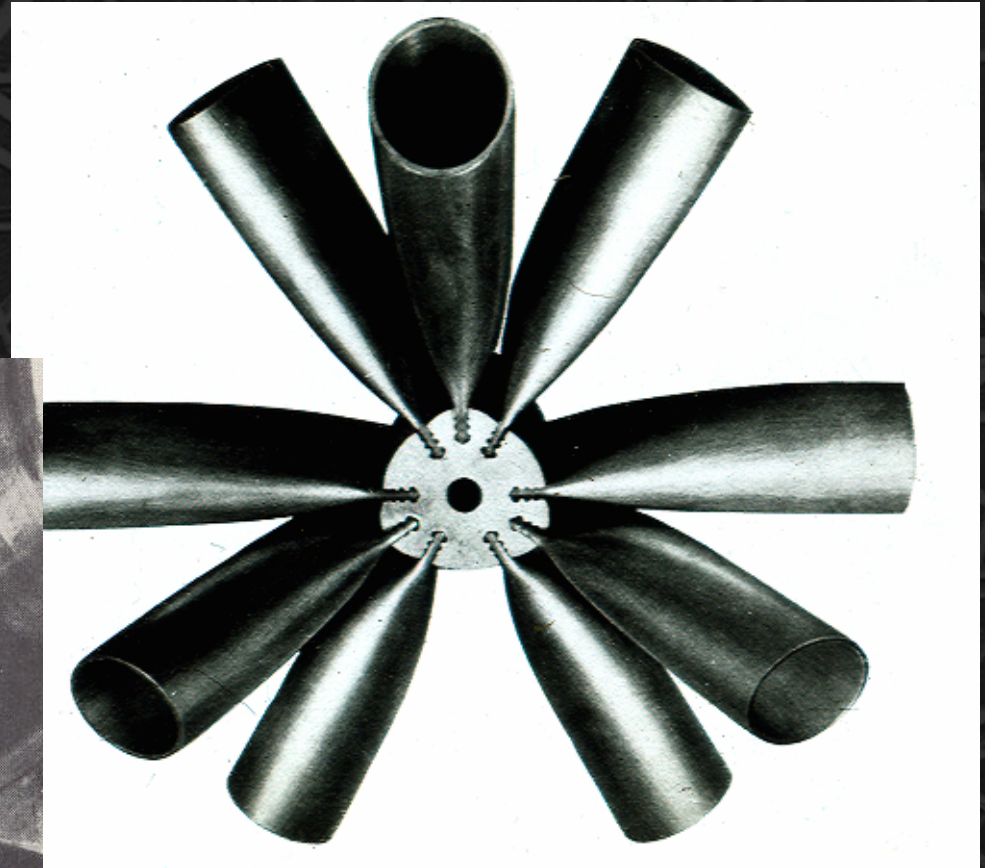
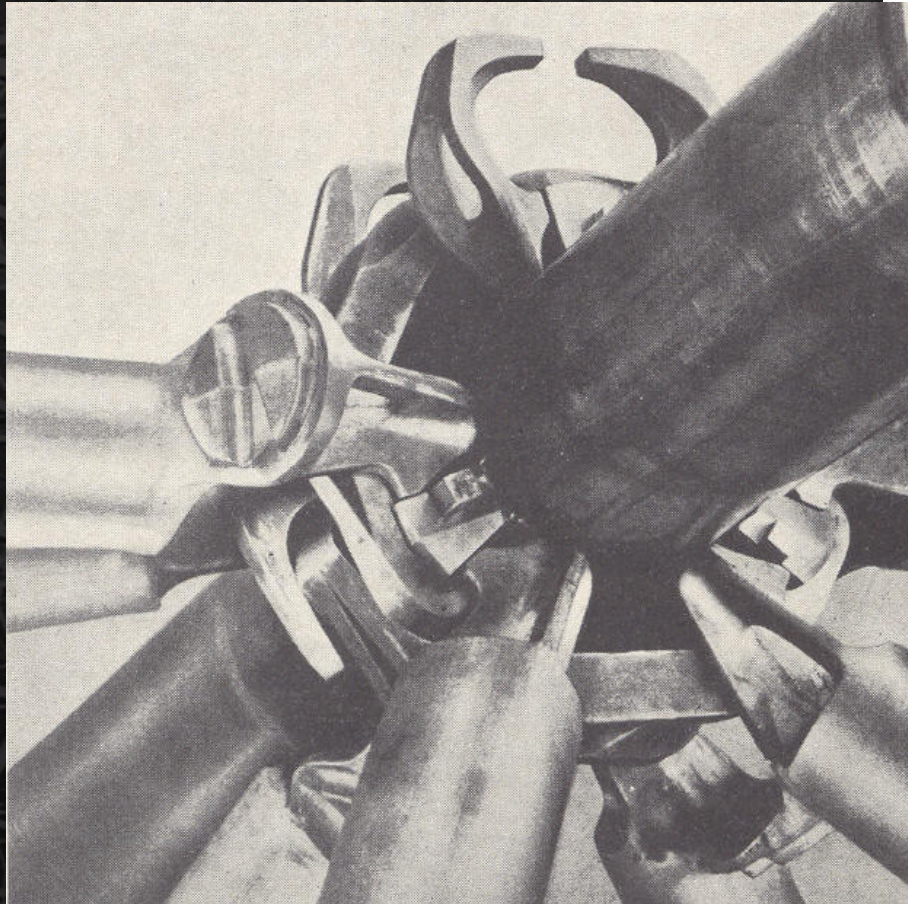

Kapcsolatok

